

CI/SFB	(52.3)	X
Uniclass	L7315	June 2012



# Built-in Shutter Systems



**SeceuroShield**  
Physical Security





# Welcome to the SeceuroShield range of Built-in Shutter Systems

Working together at every stage of your project.

## Technical Support

We can provide technical support during the important design stage of your project to assist you and ensure that you have all the information you require.

## Approved Installer Network

SWS UK has developed an extensive network of approved installers/distributors, each one selected for the quality of service they provide to their customers and the depth of knowledge they have. The distribution network covers the entire UK, ensuring that no matter where your development is you will have access to a specialist installer/distributor right on your doorstep.

## Qualified & Trained

SWS UK's experienced and professional installers have undergone rigorous training to ensure that you are always guaranteed high standards of service.

## After Sales

A comprehensive after sales service will continue to meet your needs at the end of your project and beyond.

## Safe & Secure

Safety is a fundamental concern in the continuing development of our product range. All shutters are CE marked by the manufacturer under the Construction Products Directive and we support installer CE marking under the Machinery Directive.

# The product

The aesthetic way to secure the building envelope.

## Very Unobtrusive – Very Effective

Our built-in security window shutters have been developed to provide an architecturally compatible answer to the growing need for vandalism and burglary protection on domestic and commercial property.

## Design

Built-in shutters give all the benefits of easily operated security at night, but disappear by day, leaving the building attractive and welcoming. Building the shutter box and guide rails into the wall during construction or major refurbishment achieves a neat finish and, more importantly, high levels of security. Window shutters are easy to operate from inside, manually or electronically. Where desirable, punched or perforated slats can be added to provide varying levels of vision and light. The unobtrusive design helps in meeting the demands of many of the more stringent planning authorities.

## Secure

Once the shutters are fully lowered, a mechanical lock will secure the shutter, providing high levels of security and peace of mind. The shutters may be used to achieve shading enhanced by optional light slits on the foam filled slats, or complete blackout.

## Environment

Our built-in shutters can incorporate intelligent control systems that allow the user complete control of their environment. They are able to regulate levels of light, shading, warmth and sound to suit individual requirements.



SeceuroShield Built-in Shutter  
Internal view

# Component Parts

SWS UK's built-in Shutter Systems are made to the highest standards, using a variety of high quality component parts. The result is a superior security product with high levels of performance.

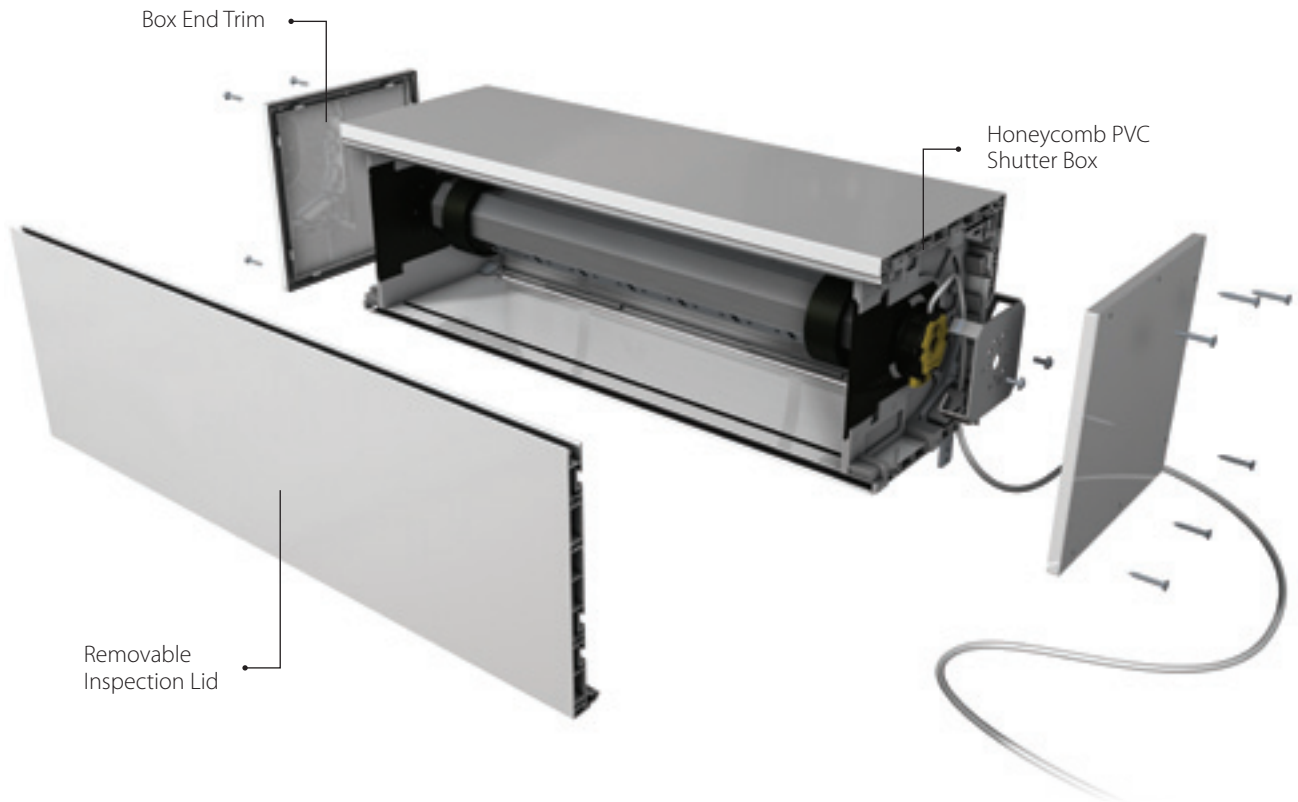

## Shutter Box

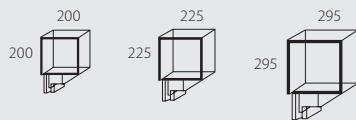

<b>Maximum Frame height</b>	1800 mm	2475 mm	3705 mm
<b>Overall height including box</b>	2000 mm	2700 mm	4000 mm

The white honeycomb PVC outer casting provides maximum insulation and prevents condensation. The removable inspection lid across the vertical internal face has a clip fitting that withstands draughts and moisture. This lid enables routine maintenance of the shutter without affecting the internal decor of the building. There are three alternative box sizes, with selection dictated by the height of the opening, as described in the table above.

### Colour options:

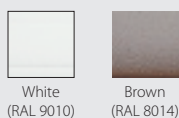

## Guide Rail

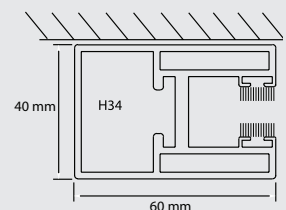

The guide rail is manufactured from extruded aluminium with a box section for fixing and high density 5 mm pile brush seals. The H34 guide profile is supplied as standard. The rail must be rebated behind the outer brickwork to achieve maximum security.

### Colour options:

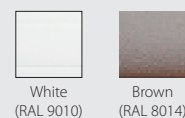

# Built-in Shutter Options

## SeceuroShield | 38 Built-on Security Shutters

A profile for domestic and commercial applications. The slimline profile of the extruded aluminium slat is double-walled, giving exceptional strength yet tight coiling for a small shutter box.

- 38 mm deep profiled twin-wall extruded aluminium slat  
*(Shown below are the perforated/punched profiles which can be mixed with the solid for added light and vision options)*

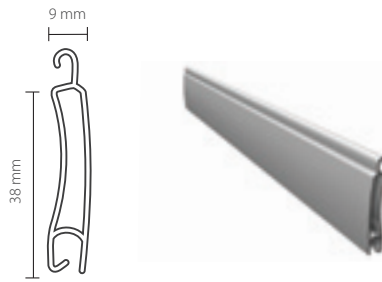

### Colour Options:



## SeceuroVision | 38 See-through Shutters

Lightweight and compact, the SeceuroVision 38 is suited to medium security applications. The attractive punched slat design is a stylish complement to contemporary interiors.

- 38 mm deep profiled single wall extruded aluminium slat
- Punched or perforated
- A clear polycarbonate glazing option is also available

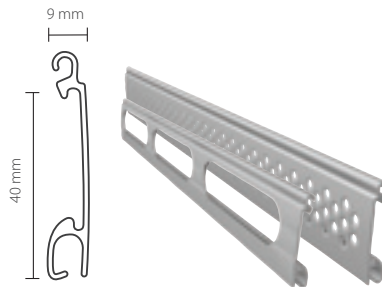

### Colour Options:



## SeceuroShield | 150 Built-in & Built-on Security Shutters

Lightweight and compact, the SeceuroShield 150 is a CFC-free foam filled aluminium slat, offering good strength, insulation and sound deadening.

- 40 mm deep profiled double wall, foam filled, rolled aluminium slat
- Spring and lock operated shutters are supplied non-vented as standard
- All other options are supplied vented as standard but are also available non-vented

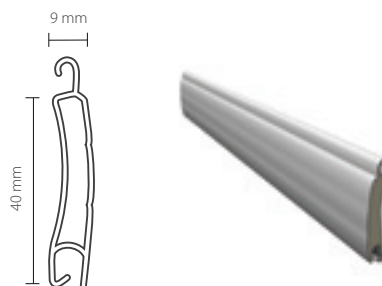

### Colour Options:



SeceuroShield 150 is only available in the basic colours shown

## Bottom Slat

Extruded aluminium with reinforcing angle. Can be supplied with rubber base or reinforcing angle.

### Colour Options:

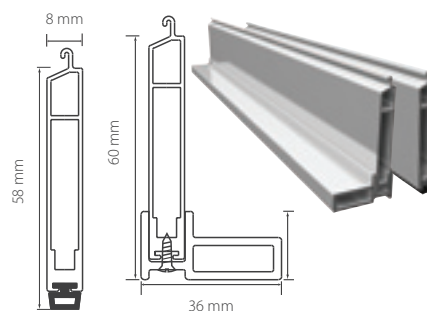

# Colour Options

Guide rails, reinforcing angles and shutters can be provided in a wide range of colour options.

- **Basic Colours** – these are the standard colours indicated below each shutter type, opposite
- **Stock Colours** – these can be provided at an extra cost from the selection below
- **Premium Colours** – these can be matched to any RAL/BS colour and are available at a fixed additional price

### Stock Colours:



**Please Note:** These colours are indicative, not actual.

# Control Mechanisms

SWS UK offers a broad spectrum of control mechanisms to suit your individual needs, from manual systems to intelligent versions that can automatically raise or lower the shutters to control light and heat within the building. Below is a small selection of the control mechanisms available. For further information and a price guide, contact your distributor.

## Group Control

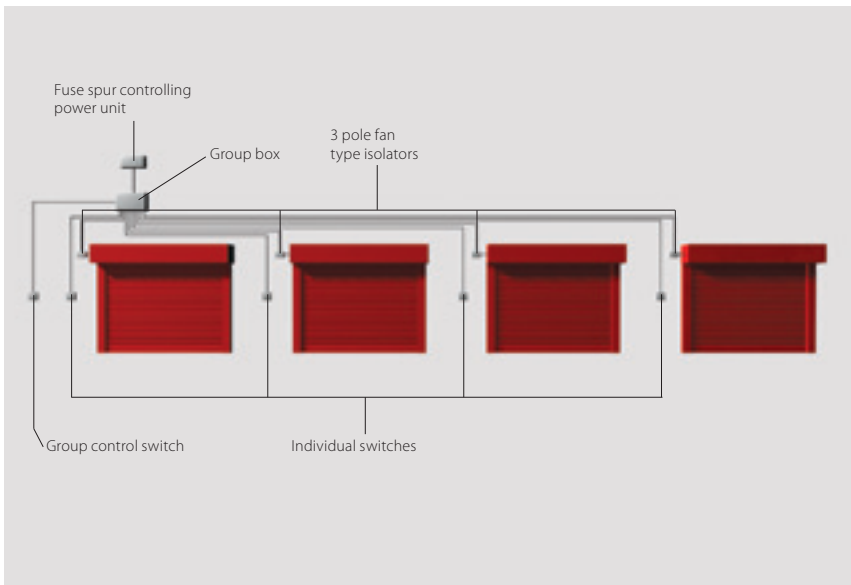

## Individual Control

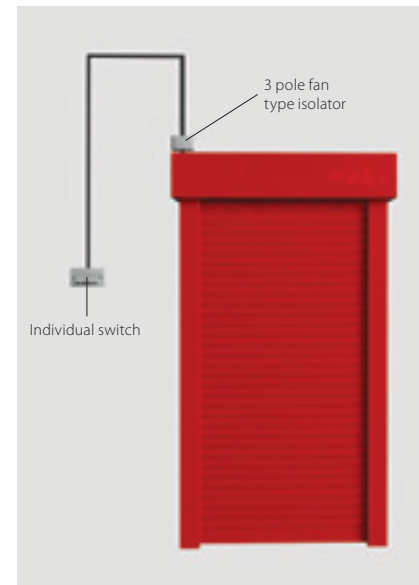

Control mechanisms are available as both single motor and group command activated motors for multiple shutters, so that shutters can be operated individually or in groups. Single rooms can be controlled individually, ensuring that the shutters are only operated in full sight of the user.

## Wired Control



### Inis Uno Single Pole Switch For One Shutter

This control is designed to control one shutter only. Group control will have multiple switches on the control box.



### Key switch

The key switch allows the user to control the shutters from outside the doorway



### Chronis

This wireless wall mounted control can be moved easily without the need for rewiring.



### Telis

This hand held unit offers complete control at the touch of a button.



### Smoove

This single channel wall switch control comes as either a mechanical or touch-sensitive control unit.



## Intelligent Systems

These intelligent control systems offer convenience and flexibility and combine ease of operation with the ability to enhance your working/living environment.

Automation solutions can be used to control ventilation, temperature, sound and natural light and so help create optimum internal conditions. Shutters can be configured to your specific requirements and adjust automatically to changing light levels, ensuring that your surroundings are always tailored to your needs.

Environmentally sensitive controls can work in conjunction with timer switches, ensuring the environment is controlled in daylight hours and then secured when the building is not in use.

# Application Details

## Outward Opening

The inner blockwork is rebated at each side by the width of the guide rail. The front of the packer is **at least flush** with the front of the frame, so that the guide rail is able to overlap both. The width of the packer is varied according to how much of the frame is to be visible and the cill continues under the guide rail.

### Plan Elevation

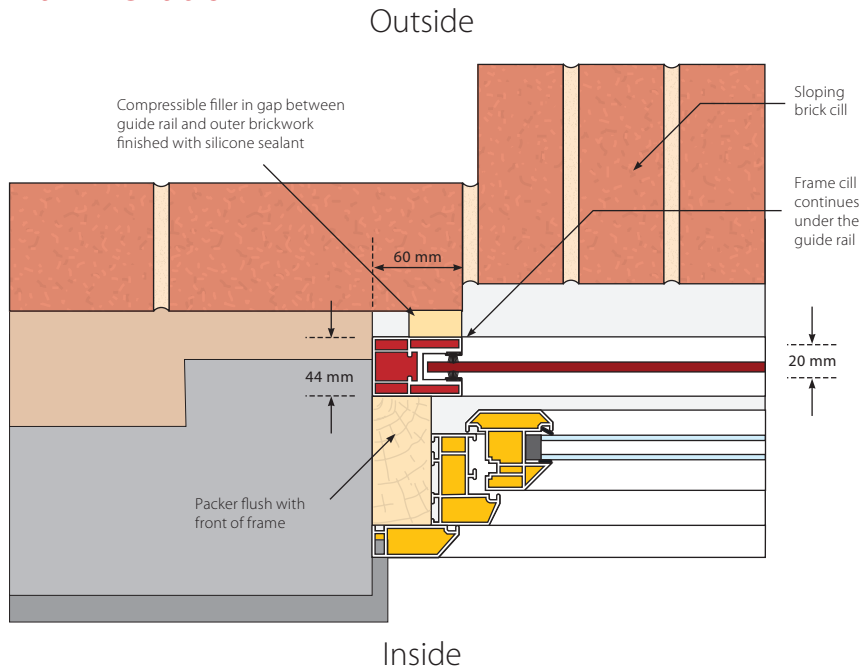

### Side Elevation

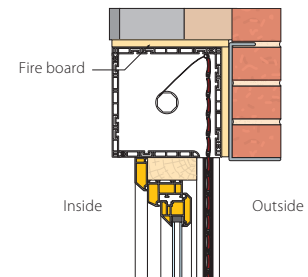

### Outward



## Inward Opening

The inner blockwork is rebated at each side by the width of the guide rail. The packer is **set forward** of the frame, at least flush with the opening lights. The packer is tailored to accommodate the 60 mm wide guide rail. The cill continues under the guide. This detail can be adapted to suit a doorway/window with a projecting handle.

### Plan Elevation

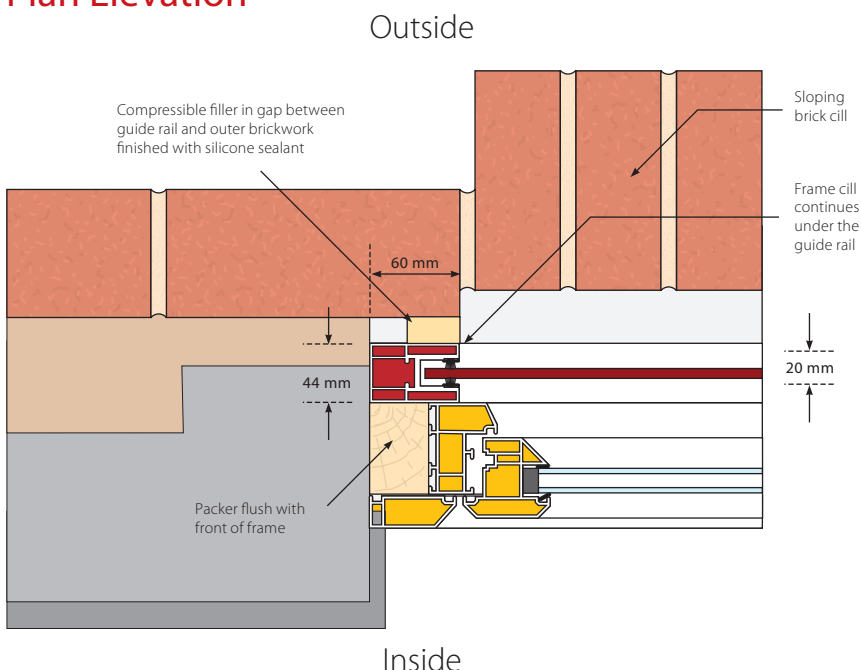

### Side Elevation

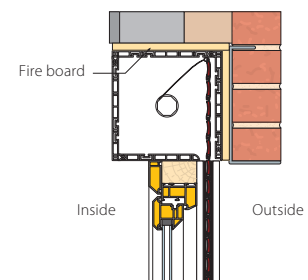

### Inward





# Typical Section

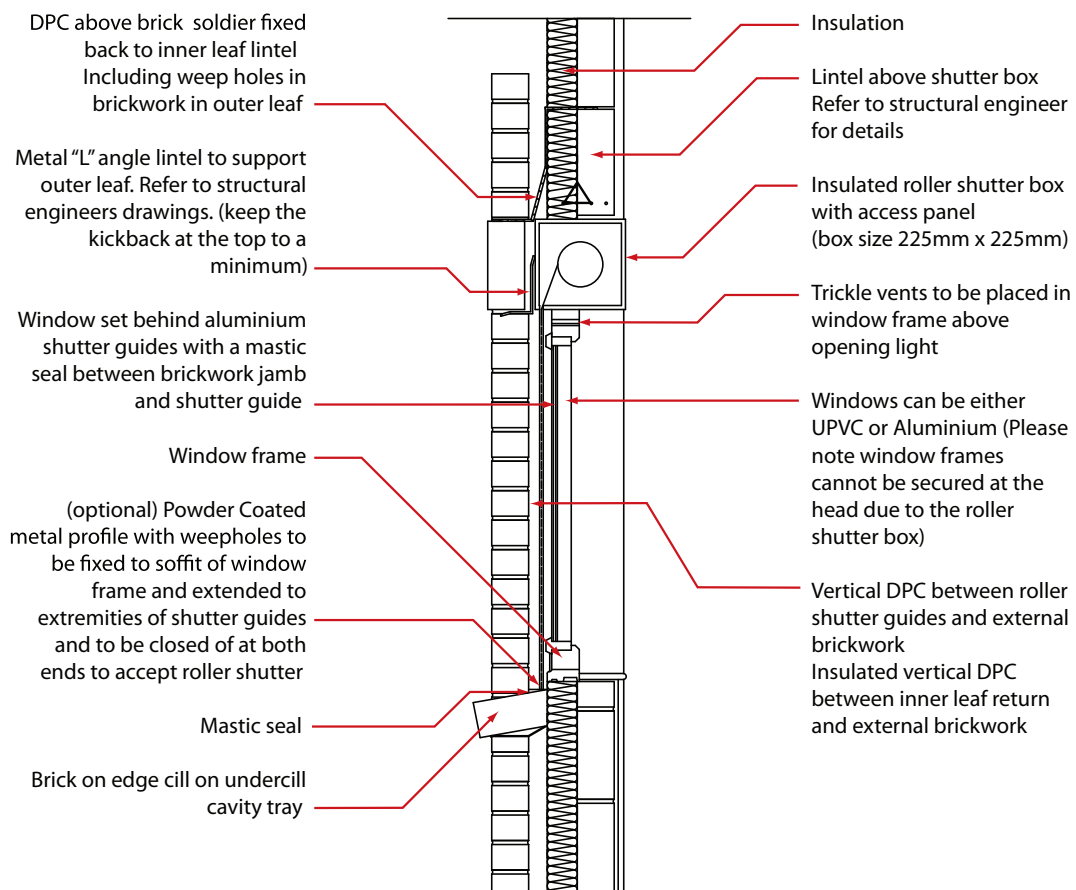
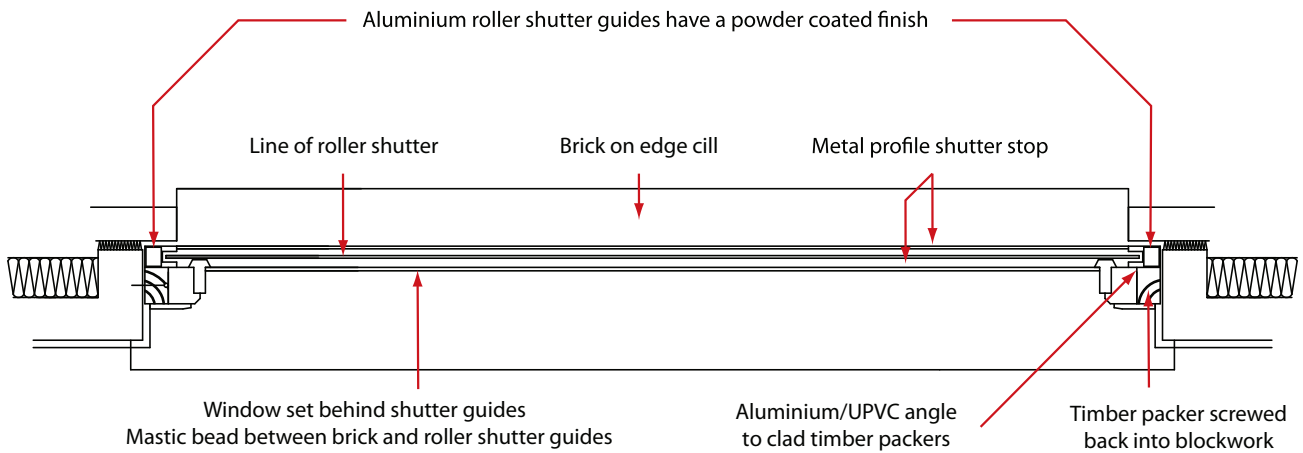

# Installation

## Step-by-Step

The installation process set out below has four simple stages. The off-site construction ensures that there are no disruptions to the build with the combined window and shutter assembly installed quickly and easily in line with the build schedule.

- 1** The window frames which the shutters are being attached to are measured to obtain the shutter dimensions. **The packers required must already be fitted to the window frames by the window manufacturer.** Dimensions must be taken from the actual windows, not drawings, as every shutter is made to measure.
- 2** The shutter boxes and guide rails are manufactured then attached to the window frame off-site – either at the point of manufacture or other suitable premises.
- 3** The window frames, complete with shutter boxes and guide rails, are delivered to site and installed by one of our approved installers.
- 4** When the building/rooms are ready, engineers attend the site to install the axle assemblies and curtains before commissioning the shutters. Access to the inspection panel inside the room must be maintained to allow for routine maintenance.

### Building Type & Material Usage

SWS shutters have been installed nationwide, including windows and doors on urban, suburban and rural homes, office buildings, factories, hospitals, schools and many more.

Our systems are flexible enough to be adapted to almost any method of construction, including stonework, metal cladding, brickwork and stone cladding, providing a practical, secure and aesthetically pleasing solution every time.

### Key Benefits

Our unobtrusive installation process offers significant benefits to builders:

- ✓ Building operations on-site can continue whilst the window is being prepared
- ✓ The system is simple and quick to install
- ✓ The system will work with any off-the-shelf lintel

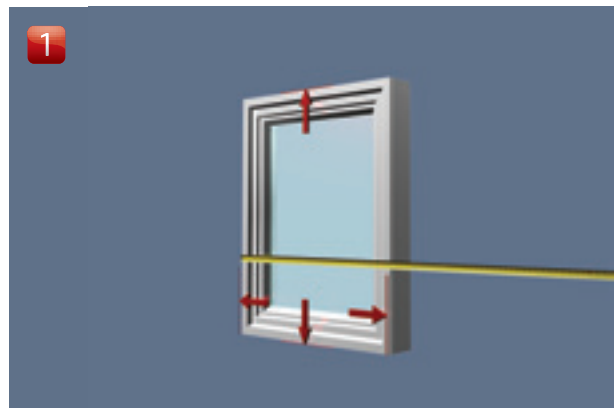

# Other Products You Might Like



## SeceuroShield Shutters

Although often overlooked securing your property provides an instant peace of mind by protecting the things that are important to you, whether that's your home and family or your business and consequently your livelihood. With the SeceuroShield range of made to measure products you have an effective answer to the growing need for protection from vandalism and burglary. The range has been engineered to allow simple integration with any building; bolstering security and deterring would be intruders. With so much choice, choosing a security product that most suits your needs can seem like a daunting task but the SeceuroShield range of industry leading products aim to offer something to suit all needs and are manufactured, supplied and installed by industry experts who can offer advice and guidance from your initial enquiry through to installation and after care.



## SeceuroGuard Retractable Security Gates

Elegant good looks with a heart of steel – the SeceuroGuard retractable security gate system combines a classic appearance with a high level of protection, ideal for the home or workplace. Available in the standard SeceuroGuard 1000 or the Secured by Design, LPCB approved SeceuroGuard 1001 our highest level security gate. Designed to keep intruders out while letting maximum light in, they are perfect for vulnerable ground floor doors and windows.



## SeceuroDoor Industrial Doors

The SeceuroDoor range of industrial doors provides a perfect solution for properties in need of a large automated door solution. Our steel shutters are available in the largest possible range of sizes with motor styles to suit the operation whether this be a standard warehouse style setting or a car park scenario where the door will be opened and closed on a constant basis. With expert advice and guidance is on hand from initial enquiry, though to installation and ongoing aftercare and service recommendations the SeceuroDoor range takes the hassle out of purchasing an industrial door.



Commercial Security



SeceuroGuard Retractable Security Gates



SeceuroDoor Industrial Doors

# Reasons to Choose SeceuroShield

## ✓ A name you can trust

When buying a SeceuroShield shutter you can be reassured by the values behind the name. Every SeceuroShield shutter is CE marked and SWS UK is an ISO 9001:2000 assessed company.

## ✓ Expert advice

With a local expert on hand you can be confident in choosing a product that suits your needs and provides a seamless finish to your property.

## ✓ Manufactured in the UK

Using the latest machinery and equipment, all SeceuroShield security products are proudly manufactured and assembled in the UK.

## ✓ A solution for everyone

With so much choice SeceuroShield security products can accommodate almost any requirement. Whether you need a built-in or built-on solution, solid or vision or need security on a small budget.

## ✓ Engineered to perfection

Through continuous development and specialist engineering, SeceuroShield security products offer unrivalled quality and the most advanced specifications.

## The importance of conformity and CE marking

To comply with the Machinery Directive both the shutter and the motor and controller used in the installation must have a **Declaration of Incorporation** from the manufacturer.

On completion of the installation the installer must provide a **Declaration of Conformity** and apply a CE mark giving details of the installation to the shutter / motor and controller combination, which is now classed as a machine.

The installer must issue to the customer a Declaration of Conformity, maintenance and operation instructions on the completion of the installation.

The installer must hold copies of both the Declaration of Incorporation and the Declaration of Conformity on a technical file for inspection by the relevant authorities.

If any of the above requirements are not fulfilled the Installation is illegal.

Please ensure for your own safety and peace of mind that whoever installs your electric motor and controller is both willing and able to fulfil these requirements; if they are not – do not use them.

As a member of the DHF we CAN and WILL install your motor and controller safely and legally.

## Peace-of-Mind Warranties

All SeceuroShield products are guaranteed against defect of material or workmanship by SWS UK, subject to correct installation, maintenance and operation, for a period of 2 years from the date of purchase. The Somfy Motor carries a 5 year guarantee.



### Address

Amore Cattura  
Silver Street  
Bredgar  
Kent  
ME9 8ES

TEL: 08451 550042  
FAX: 07540051 192

